

PRECISION OPTICS FOR PRECISION SHOOTING



*World Record 10-shot group,  
2.815 inches at 1000 yards.  
See page 13.*



## You cannot buy a higher quality riflescope.

That's a strong claim, without a doubt.

But, it's a claim we can prove. And our customers *do* prove it...every day, under some of the harshest, most unforgiving conditions on earth.

We didn't start building scopes and expect people to find uses for them. Instead, we looked at real-world needs...needs that were not being met by other optics manufacturers. Created from the ground up, Nightforce designed the ultimate precision instrument for the intended application.

You can tell the difference the moment you pick one up. If you could look inside a Nightforce scope, the differences would be even more obvious.

Fortunately, looking *through* one will tell you just about everything you need to know.

**Glass-etched illuminated reticles** are standard with every Nightforce scope.

**New! Hi-Speed elevation and windage adjustments are standard on all Nightforce NXS scopes (except Compact models). Now, twice as fast!**



**All air-to-glass surfaces** receive our proprietary broadband multi-coating; applied to tolerances of 1/4 wave deposition or .00005 inches, exceeding the toughest Mil-Spec abrasion test. You will see the difference in low-light situations.

**Every lens in a Nightforce scope** is perfectly matched and aligned by hand with all other lens elements. This technique, called optical indexing, yields the highest possible optical performance. Because it takes time and considerable expertise, many manufacturers don't bother. We've done it this way since the beginning.

**A scope's objective lens** determines resolution, light transmission and exit pupil size. To maximize these attributes, every Nightforce objective lens assembly utilizes a multi-element design like those found in the highest quality telescopes. Our lens system focuses light rays more precisely for exceptional image clarity and color accuracy.

**Nightforce tubes** are machined from solid bar stock 6061-T6 aircraft-grade aluminum alloy, not extruded or formed like those found on lesser scopes. They are two to three times thicker than other riflescopes. This means less overall stress, greater thermal stability, a consistent zero and a virtually impervious shield for the precision optics within.

**Sand, dust, mud, heat and cold** are a few of the environmental challenges every Nightforce scope faces in its development. Every aspect is thoroughly tested, proven, and tested again before we build a final product. Anything you can inflict upon a scope, you can be certain we've already done it first.



**The spring that maintains pressure on our elevation and windage adjustments** spends two weeks in a polishing tumbler before going into a Nightforce scope, to assure there are no rough spots or burrs to interfere with perfectly smooth operation. It is made of pure titanium, the only known metal in the world that can be repeatedly compressed and held in place, even for years, without developing fatigue or "memory." This guarantees zero loss of integrity, zero loss of repeatability. It is many times more expensive than comparable springs found in most scopes. But, we are not concerned with a few dollars. We are concerned with building the best riflescope.

**The terms "rugged" and "precision optics"** are usually not compatible. Any optical instrument built to highly exacting tolerances and absolute alignment is by its very nature a delicate device.

Not so with Nightforce. The design of our scopes is unique within the industry, allowing us to combine optics of extraordinary precision with construction that will withstand repeated recoil from the largest calibers, extreme shock and severe temperature changes.



**We machine the screw that controls elevation adjustments** to an unbelievable 110 threads per inch. It is so precise that it must be mated to its receiver by hand. Why go to so much trouble? Because we consider backlash clearance of more than 1/30 the thickness of a human hair unacceptable.



A hand-signed Quality Assurance tag means your Nightforce has been thoroughly tested and approved.

**Adjustments** are made with hardened silicon bronze to ensure a lifetime of wear resistance and reliable performance. This is not the easiest way to build a scope. It is, however, the best way to build a scope...providing a lifetime of repeatable accuracy.

**Lenses are painstakingly bedded** with our own proprietary Mil-Spec formulation. Unlike methods used by most other scope manufacturers, with our bedding process there is no glass-to-metal contact that can result in breakage, stress or misalignment over time. Our process is 100% permanent, guaranteeing perfect optical alignment for as long as you own your Nightforce scope.

**The optical elements** within an NXS scope are hand-bedded with our own proprietary Mil-Spec bonding agent, then cured at 160° F for 24 hours. Lenses are further secured with o-rings and machined metal lock rings, both fore and aft. This zero-tolerance lens securing method prevents any movement of

the optical elements in any direction, under any circumstance. This permanent bonding assures a lifetime of uncompromising performance and reliability, confirmed with front and side impact testing on every scope we build.

# WHAT SOME COMPANIES CALL CLOSE TOLERANCES WE CALL INTOLERABLE.



3.5-15 x 50/56 Hi-Speed adjustments, L to R:  
 .250 MOA with ZeroStop  
 .250 MOA  
 .1 Mil-Radian with ZeroStop



**ZeroStop™**  
 NIGHTFORCE

**An instant return to zero every time.**

After sighting in your rifle, set the patented Nightforce ZeroStop™ feature, and you can make all the elevation adjustments you wish... then return to absolute zero instantly and positively just by feel, even in total darkness. No counting clicks, no visual reference necessary. Offered on 1-4, 2.5-10, 3.5-15, 5.5-22 and 8-32 NXS scopes. Available in .250 MOA and .1 Mil-Radian.

Our 3.5-15 x 50 is also offered as the F1, with a reticle in the first focal place. See page 22 for more information.

Military & law enforcement  
 Long-range hunting

### 3.5-15 x 50 NXS

Originally developed for use on military small arms, the 3.5-15 x 50 NXS allows a lower mounting profile. A practical magnification range and large field of view make it an invaluable scope for professionals and serious hunters as well.

A full 110 MOA of internal adjustment make both 3.5-15 models extremely versatile in the field and applicable to a wide range of applications.



Available with  
**ZeroStop™**  
 NIGHTFORCE

### 3.5-15 x 56 NXS

The top choice for law enforcement snipers. A large objective lens increases resolution and exit pupil size for quicker target acquisition and optimal light performance in twilight conditions...an especially useful configuration for tactical teams that may not have a dedicated night vision scope. This superior optical design also benefits hunters and sport shooters who want a scope to perform in the shadows. It offers a full 110 MOA of adjustment and a practical magnification range. A large field of view allows the shooter to recover quickly from recoil for a second shot.

Military & law enforcement  
 Long-range hunting



CREATED FOR PEOPLE WHOSE LIVES  
 DEPEND ON THEIR SCOPE.

**Our scopes are subjected to abuse during product development** that would quickly destroy lesser optics. Pre-production scopes are tested in a pressure tank simulating 100 feet of water for 24 hours, ensuring absolute waterproof integrity. We test thermal stability by freezing them to -80° F, then heating them to 200° F within a one-hour period. Function is checked at both temperature extremes. Recoil and impact are tested at 1,250 Gs for both positive and negative forces.

Before it is shipped to a customer, every scope is completely inspected and checked at 70 to 130 different points, depending on the model. A battery of tests, including forward impact, side impact, tracking accuracy and resolution integrity. These are but a few of the steps we take to insure absolute quality before any scope leaves our facility.

Whatever you think you might do to your scope, chances are we've already done it.

**The hole you see** in the well-used Nightforce 3.5-15 x 50 NXS scope at right was made by an enemy 7.62x39 round fired at a U.S. soldier. The bullet completely penetrated the erector tube—the heart of the scope's optical system. We're happy to report that the soldier was not injured, and the only casualty is the scope's magnification ring, frozen on 15x. Its focus, tracking, and all other functions work just fine. It holds point of aim like new.

The soldier wrapped the scope in duct tape to keep out sand and dirt, and used it without a problem for the next three days, completing his mission.

We receive many stories like this. Because Nightforce riflescopes are used in active theatres by most of the elite special forces worldwide, they are subjected to—and survive—the most brutal conditions imaginable.

We won't say they're bulletproof. There is at least one soldier, however, who would argue otherwise.

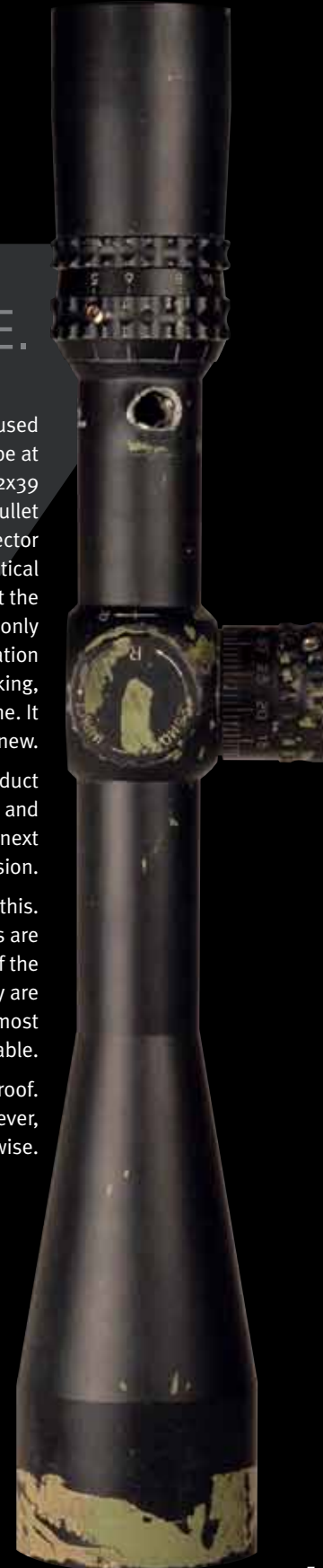





Leo Anderson, holder of several 1000 yard world records, knows how to hunt, too. He took this fine pronghorn with one shot at 1200 yards. Leo's advice? "Precision long range hunting demands a Nightforce scope!"



Once again, using Nightforce scopes, the USAMU Service Rifle Team cleaned house at the 2008 Interservice Highpower Championships and 2008 NRA Long Range Championships:

- First, second and third place/600 yard Division B (any rifle, any sight), including a new match record for SFC Lance Dement
- First, second and third place/1000 yard Division B
- First, second and third place/Long Range AGG, including a new match record for SGT Brandon Green
- First, second and third place 2008 Wimbledon Cup
- 1000 yard Division B Team Match (USAMU Praslick team)
- Herrick Team Trophy, also to USAMU Praslick

USAMU shooters have taken the Wimbledon Cup in 2006, 2007, 2008 and 2009. The Praslick team has won the Herrick Trophy in 2005, 2006, 2007 and 2008, including breaking a national record in 2006 that stood for over 20 years.



SFC Lance Dement with the 2009 Wimbledon Cup. This is four years in a row for a member from the USAMU team to win this trophy.



Derek McDonald, Surefire's vice president of marketing, training with Nightforce at the Rifles Only facility.

"I have three of your 5.5-22 NXS scopes....I shot the groundhog at 1803 yards...witnessed and verified. [My] guns have your fine optics on them and the shots could not be made with lesser equipment."  
—Danny Edwards



#### When is "long range" too long?

Because high-magnification Nightforce scopes were originally designed for highly trained professional sharpshooters, they are capable of remarkable accuracy at extreme distances. For the hunter, this means that killing shots at game previously "out of range" are now possible...but only if the hunter is intimately familiar with his rifle, his loads, rangefinding techniques, and after extensive practice. Nightforce scopes will put extreme long range capability in the hunter's hands. It is up to the hunter to use this capability wisely and ethically.



have never changed and it still works perfectly.

"Nightforce is the best I have ever used."

—Kent A. Lomont  
Manufacturer and dealer of machine guns and destructive devices

Above: the 14.5/114 Russian shown actual size.



5.5-22 x 50/56 Hi-Speed adjustments, L to R:  
.250 MOA with ZeroStop  
.250 MOA  
.1 Mil-Radian with ZeroStop

Military & law enforcement  
Long-range hunting

### 5.5-22 x 50 NXS

Originally developed for the U.S. military's extreme long range shooting and hard target interdiction, both 5.5-22 Nightforce models provide a broad magnification range, four inches of eye relief and 100 MOA of elevation travel. These characteristics have proven highly appropriate for the .50 BMG, allowing shooters to accurately reach to 2000 yards and beyond. It retains a slim profile and is easily adaptable to a wide range of mounting systems. The superb resolution at high magnification also opens an entirely new world of extended range for the accomplished marksman.

Available with  
**ZeroStop**  
NIGHTFORCE

### 5.5-22 x 56 NXS

The ultimate long range scope. Its 56mm objective lens provides maximum clarity and resolution across the entire magnification range. The most advanced field tactical scopes ever produced, the wide magnification factor of our 5.5-22 series allows precision accuracy at the longest ranges, yet at 5.5 power remains highly effective for shots at close ranges. Nightforce was the first company committed to perfecting extreme magnification variable power scopes. Our years of experience perfecting long-range optics is evident in every scope we build.

Military & law enforcement  
Long-range hunting

**BUILT FOR PROFESSIONALS.  
SO YOU CAN SHOOT LIKE ONE.**



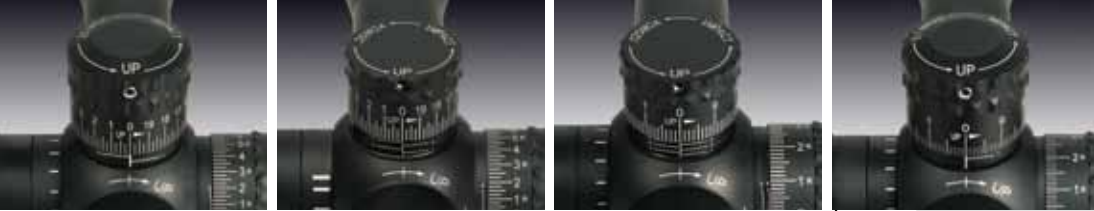

8-32 x 56 Hi-Speed Adjustments, L to R:  
 .250 MOA with ZeroStop  
 .250 MOA  
 .125 MOA  
 .1 Mil-Radion with ZeroStop

### 8-32 x 56 NXS

Varmint shooting  
 Target shooting  
 Extreme long range

Since 1992, Nightforce has been a winner in countless benchrest competitions. We have taken that knowledge and success and combined it with the durability and features of our NXS line to create the ultimate long-range field and target scopes. Evolved from our tactical line, the 8-32 x 56 and 12-42 x 56 offer fast adjustments for precise, repeatable shot placement. The extremely high magnification ranges mean there is now virtually no target outside the capable shooter's reach.



New! Available with  
**ZeroStop™**  
 NIGHTFORCE

### 12-42 x 56 NXS

The highest magnification scope we make. It provides optical resolution comparable to the highest quality spotting scopes and unsurpassed clarity across the entire magnification range.

Both the 8-32 and 12-42 utilize 56mm objectives specifically designed for optimum resolution under all conditions—even at the highest magnification. In the past, accomplished long-range shooters could only wish for a scope equal to the capability of modern flat-shooting calibers. The question now becomes, does your rifle measure up to the 12-42 x 56 NXS?

Varmint shooting  
 Target shooting  
 Extreme long range

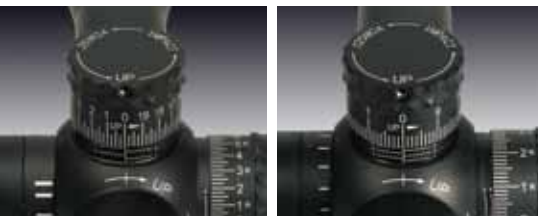

12-42 x 56 Hi-Speed adjustments, L to R:  
 .250 MOA  
 .125 MOA

*John Whidden has a lot to smile about these days. He was a member of the winning Herrick Trophy team at Camp Perry. Twice, he's won the National Championships for Long Range Highpower and the Canadian Cup. Several times he's taken Georgia State 1000 yard and 600 yard championships. All with Nightforce.*



## NOW THE QUESTION BECOMES: DOES YOUR RIFLE MEASURE UP TO OUR SCOPE?

It might come as a shock to the shooter who has just invested a small fortune in a fine rifle, but the fact is that a Nightforce scope is built to tolerances vastly more precise than those found in the best rifles money can buy.

Why? Because even the slightest error in a riflescope's construction will be magnified dramatically as range and power settings increase; and evident in a constantly shifting zero and frustrating lack of repeatability.

Quite simply, to achieve the absolute maximum accuracy from your rifle, your scope must be as close to perfect as possible.

Less precise riflescopes can—and will—fail to match the potential of a well-made firearm. With Nightforce, whatever your rifle is capable of, your scope will more than measure up.

**The Class of F-Class.**  
 Team USA shortly after winning the 2009 F-T/R World Championships, beating out the home team in Great Britain.



SGT Brandon Green, winner of the 2008 and 2007 Wimbledon Cup national championships as part of the USAMU Service Rifle Team. He also set a new match record in Long Range AGG, took first in 1000 yard Division B, and second in 600 yard Division B at the 2008 Interservice Highpower Championships, all with Nightforce.



We put our heart and soul into building the ultimate optical instruments, and we're extremely proud of the long-standing commitment of competitors like Sgt. Green to Nightforce. After all, we're shooters, too. And we like to win as much as anyone does.



Nightforce compact NXS models prove that a riflescope needn't be large and bulky to be highly efficient. Not that building a small scope offering high performance is easy. Like a fine watch, tolerances, materials, and optical design must be as close to absolute perfection as humanly possible. Few companies have the skill, the resources, and the desire to create such a precision instrument. Our compacts were originally designed for—and are still in use by—the U.S. Special Operations community, whose demands are uncompromising. When you hunt with a Nightforce compact, you won't be making any compromises, either. All you'll be giving up is bulk, weight, and inconvenience.

*"I am a strong believer in all your products...I highly recommend them."*

—Will Barks



**Why are there so few scopes on the market** offering variable magnification beginning at one power? It is extremely difficult to build a true 1x variable scope while maintaining absolute optical integrity and alignment throughout the entire magnification range. For the hunter, having the option of one power—zero magnification—makes our 1-4 x 24 NXS the only true substitute for open sights on a dangerous game rifle. For the military/LE professional, it can be a lifesaver in CQB situations (especially with our FC-2 reticle). A top choice for three-gun competitive shooting as well.

NXS Compacts are available with .250 MOA and .1 Mil-Radian adjustments.

## 1-4 x 24 NXS

If hunting big, dangerous game is your passion, there is no better scope on the market to keep the odds in your favor. Its low profile complements big bore bolt action and double rifles. At 1 power, it is as quick as open sights and vastly more precise, allowing you to shoot with both eyes open. Your field of view is a full 100 feet at 100 yards, providing instant target acquisition and precise shot placement. It is designed for hunting dangerous game at close quarters, in dense brush, and for running targets. It is one of the few scopes in the world that will withstand repeated recoil from the largest magnum calibers.

Dangerous game  
Military and law enforcement  
CQB applications  
Tactical competition



**1** Nightforce compacts are available with two types of adjustments:

1. Fully enclosed with caps (shown with caps removed at left; caps installed on 1-4 x 24 at right). Windage and elevation controls are easily adjusted with fingertips.



**2** Exposed tactical-style adjustments standard with Nightforce **ZeroStop™** and windage limiter technology. With **ZeroStop**, after sighting in your rifle you can lock your zero to any one of the 400 elevation clicks, then return instantly to absolute zero by feel, regardless of how many elevation adjustments you have made. Your choice depends upon the type of shooting you do and whether or not you need instant access to all adjustments. Other adjustment configurations are also available.



Available with **ZeroStop™**  
NIGHTFORCE

## 2.5-10 x 32 NXS

To address the requests of hunters for a scope with even greater low-light capability, yet light in weight and low in profile, we've created an all-new NXS with a 32mm objective lens. At just 12 inches in length, it represents the optimum in size-to-weight performance. A larger exit pupil makes for faster target acquisition, and there are no parallax or focusing issues to slow you down in the field. It outperforms most larger scopes, proving that size is no substitute for quality.

Shown with optional **ZeroStop™** and windage limiter adjustments.

Big game hunting  
Tactical competition  
Military and law enforcement

**Gray's says Nightforce is best**

Gray's Sporting Journal selected our 2.5-10 x 32 NXS as "Gray's Best" in riflescopes for 2010, saying it "breaks new ground in usability."

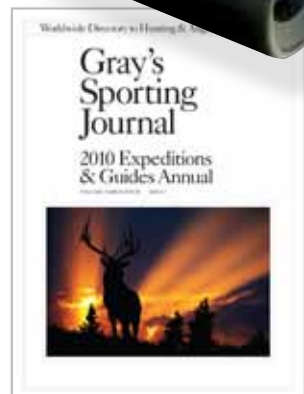

**NIGHTFORCE COMPACTS.**  
BUILT TO TOLERANCES THAT WOULD  
MAKE A WATCHMAKER JEALOUS.



Reticle FC-2



Reticle NP-1

**Illuminated reticles** are standard with every Nightforce scope. Nine illumination levels are easily controlled by a third adjustment on the left side of NXS compact scopes.

Our Velocity reticles are the answer for a hunter seeking an effective ballistic solution without complicated calculations. Up to twice as fast as traditional rangefinding reticles, Velocity reticles provide accurate aim points to 600 yards, plus 5 and 10 mph windage compensation. After sighting in the rifle, the hunter need not worry about drop charts or adjustments in the field. The 600-yard Velocity reticle is available on the 2.5-10 x 32 NXS, and a new 1000-yard version on 3.5-15x and 5.5-22x Nightforce NXS scopes. Visit [www.nightforceoptics.com](http://www.nightforceoptics.com) › reticles overview and follow the links to our online ballistic calculator to learn more.

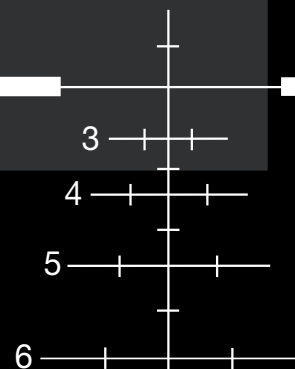





## 8-32 x 56 Precision Benchrest

General target shooting  
Competition

## 12-42 x 56 Precision Benchrest

Competition

Each of our Precision Benchrest models feature 56mm multi-coated lenses, providing the superior resolution necessary to distinguish fine detail at extremely long ranges. An adjustable objective allows extra-fine focus to adjust parallax from 25 yards to infinity.

Target adjustments are calibrated in true .125 MOA (1/8 click) values and can be re-indexed to zero after sighting in.

Both Precision Benchrest riflescopes are equipped with a coil spring plunger return system to maximize tracking accuracy. The eyepiece provides fast reticle focusing, and a glass-etched illuminated reticle provides optimum image/reticle contrast under virtually any lighting conditions.

You have two choices of magnification ranges. But only one choice in the ultimate benchrest riflescopes.

### Another year, another world record with Nightforce

Every year since 2003, Leo Anderson has added more and more titles to his collection of 1000-yard world records. In 2008, through the PA 1000 Yard Club, Leo shot Heavy Gun Class Records for six-match group aggregate (5.0735") and ten-match aggregate (6.1732"). Leo still holds four 2007 world records in Light Gun Class. Leo said, "to shoot the best you have to shoot the best equipment. That's why I shoot Nightforce. Customer service is excellent...Nightforce is a great company to deal with."



# MORE LONG-RANGE RECORDS THAN ANY OTHER RIFLESCOPE.

Since 1992, Nightforce riflescopes have won more records in long-range benchrest competition—including several world records in .50 B.M.G. 1000 yard benchrest—than any other scope on the market. Both Precision Benchrest models include an externally adjustable illuminated reticle, true .125 MOA click values and a broad range of internal adjustment.

These are not "dual-purpose" or hunting scopes with a different name. Each was designed and built from the ground up to answer the specific demands of the long-range benchrest shooter.

Actual size 10-shot group,  
2.815 inches, 1000 yards, by  
Matthew D. Kline

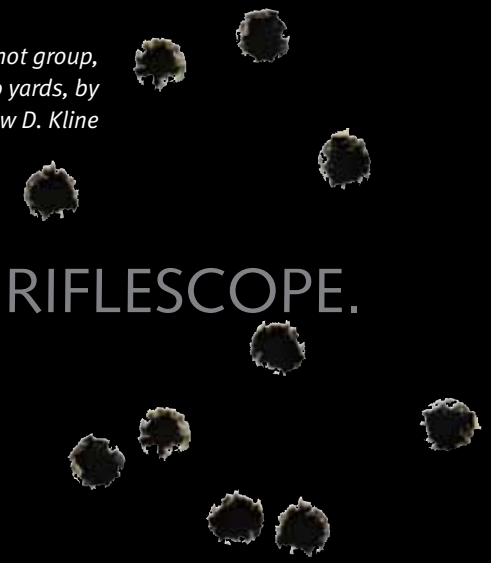

### World record shattered!

On September 12, 2010, Matthew D. Kline broke the three-inch barrier for the first time with a new 1000 yard

10-shot Heavy Gun World Record of 2.815 inches, 100-4x. He used a 300 WSM topped with a Nightforce 8-32 x 56 Precision Benchrest scope. Our congratulations to Matt.



### Ballard dominates F-Class again in 2009

Charles Ballard continues to win with his Nightforce benchrest scope:

2009 NRA Long Range Regional Championship (F-Open)

2009 Spirit of America Fullbore National Championship (F-Open)

2009 NC State F-Class Championship

2009 US F-Class Championship

In 2008 he won the U.S. F-Class Nationals, the NC State F-Class Championship, the NRA Long Range Regional Championships (F-Class Open Div.), and set a world record 200-13x at 1000 yards. In 2007, 600- and 1000-yard national records. "My 12x42 Nightforce played a huge part," Charles said. "The 1/8 MOA adjustment and high magnification are must on the new reduced F-Class targets. Nightforce scopes have flawless tracking, lash-free parallax adjustment, superior resolution and unequalled light transmission. Combined with the unobstructed view of the NP-2DD reticle, and you have the finest F-Class rifle scope available."

### 2006 World Record

Cody Finch produced a new 1000-yard world record for group (Light Gun Class) in 2006, placing 10 shots in 3.835" with his Nightforce 12-42 x 56. "I honestly think it's the best scope out there," he said. "If you want to win at this game, you'd better use a Nightforce."





# THE ONLY POSSIBLE WAY TO IMPROVE A NIGHTFORCE SCOPE.



## Nightforce one-piece steel bases

An integral recoil lug machined on the bottom of the base provides a precise fit when bedded to the rifle's action, preventing any movement of the base or recoil stress on screws holding the base to the receiver.

Our one-piece bases are machined to exact Picatinny Mil. Std. 1913 specification rail dimensions. This design allows the same scope to be used on several different rifles, always optimizing eye relief. 20 MOA taper standard, 40 MOA offered for Remington 700 only. Designed for right-or left-hand actions, our bases will never interfere with loading or extraction.

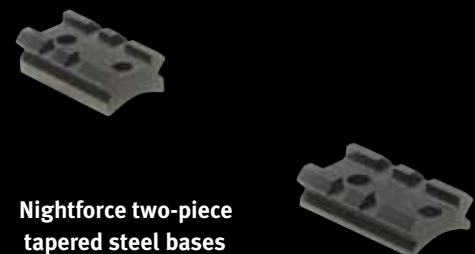

## Nightforce two-piece tapered steel bases

Also made to Picatinny Mil. Std. 1913 specifications, our two-piece bases are machined to an angle of 20 MOA and finished with a matte black mil-spec coating. Allows mounting of scope to retain the maximum amount of internal elevation adjustment. This will allow you to shoot further and still maintain a 100 yard or less zero.



## Nightforce gunsmith bases (steel or aluminum alloy)

These Picatinny base blanks allow you to customize the length, height, radius and hole spacing to your specific application. Standard taper is 20 minutes (20 MOA).

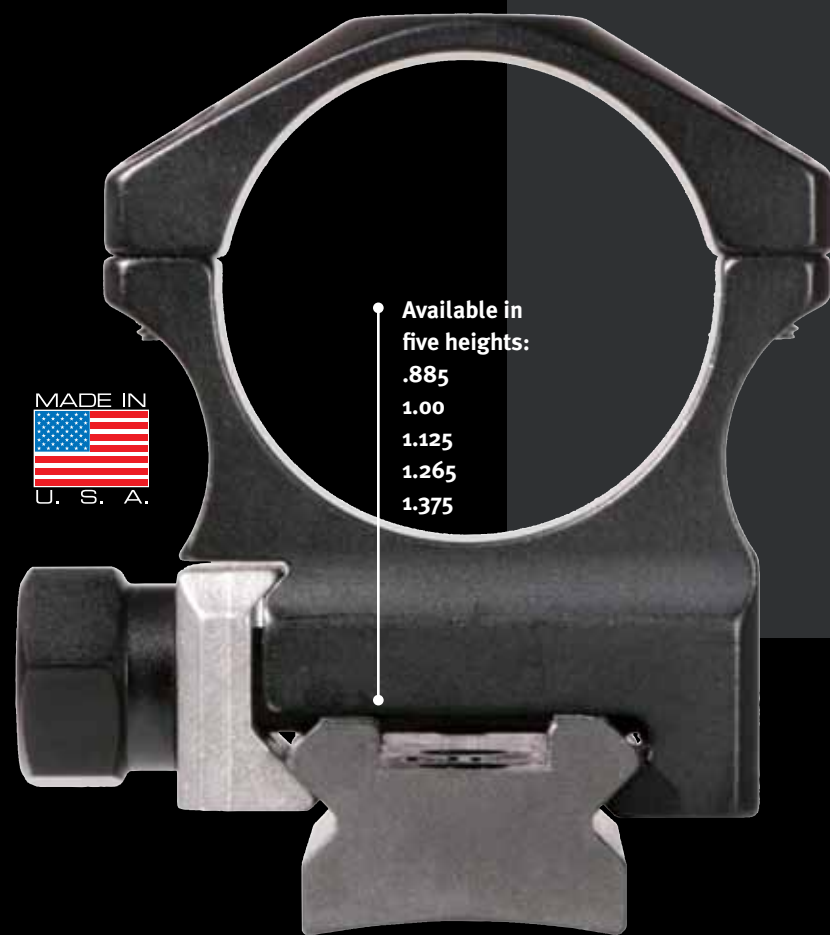

## Nightforce steel rings

Designed to fit Picatinny Mil. Std. 1913 scope bases, we machine a load-bearing recoil lug on the grade eight crossbolt. This lug precisely matches the machined cross lug of the Nightforce base, providing perfect alignment and superior accuracy.

We design and produce Nightforce 30mm rings in-house to our own exacting specifications; we believe they are the highest quality rings available on the market.

The finest riflescope in the world is only as good as its mounts. That's why we recommend Nightforce rings and bases to make certain you're getting every bit of performance from your Nightforce scope.

Our bases are CNC machined from a single billet of steel. They are precision machined to match the receiver contour, ensuring straight and true alignment. This also reduces the amount of internal adjustment required when zeroing your rifle. All Nightforce rings and bases exceed military design specifications. They are tough, reliable, utterly precise, and are the perfect match for your Nightforce riflescope.



Available in five heights:  
 .885  
 1.00  
 1.125  
 1.265  
 1.375



## Ultralite rings Ultralite Unimount

When a tough, reliable mounting system is required without adding substantial weight, Nightforce Ultralite rings are the answer. They feature CNC machined 7075-T6 hard anodized black aluminum bodies and titanium beta series crossbolts and jaws. This unique construction provides exceptional strength, normally not found in lightweight rings. Testing has proven that this combination is actually stronger than steel.

Only 1/3 the weight of steel rings.



## Direct Mount

This Nightforce system combines a high quality CNC machined 7075-T6 hard anodized aluminum base with an integrated ring design. Built to mount directly to your Remington 700 short or long actions, the 20 MOA taper maximizes internal adjustment. The Direct Mount ensures true alignment and maximum strength for precision shooting. Like all Nightforce mounts, it incorporates an integral recoil lug which prevents any movement of the base or stress on the screws attaching the Direct Mount to the receiver. It is the ultimate in a weight-saving one-piece design.

## Nightforce Angle Degree Indicator with Mount

The Nightforce ADI takes the guesswork out of uphill and downhill shots. Calibrated in degrees, it gives you an instant readout which you can enter directly into the Nightforce ballistic software program on your pocket PC or use with a pre-printed angle drop chart. It is available in two versions: (1) a two-piece, low-profile Mil-Spec 1913 mount for one-piece bases that allows easy installation without removing the scope (shown below); and (2) as part of our top ring bubble level system (at left). It is simple, robust, and requires no batteries. Available in right-hand or left-hand rifle action configurations.



## Top Ring Bubble Level/ADI

Replaces the top ring of our Unimount, Direct Mount and standard rings without a Picatinny base. Available with integral ADI mount or as top ring/bubble level only.



## Unimount

The Nightforce Unimount is designed to remain on the scope at all times, allowing quick removal of the scope or interfacing with different firearms. It is the most accurate Picatinny Mil. Std. 1913 mount available, incorporating a built-in 20 MOA taper to maximize long-range capability. The Unimount is the ultimate mount for attaching to weapons with an integral Picatinny flat top-type receiver.

Precise tolerances ensure that the riflescope is not subjected to stress, strain or bending as the ring screws are tightened. CNC machined from 7075-T6, the Unimount is finished with a matte black coating.





# YOU CAN SPEND DAYS AND DAYS AT THE RANGE. OR A FEW MINUTES WITH OUR SOFTWARE.

## The tools to shoot more accurately...every shot.

The Nightforce Ballistic Program is the most accurate, easy-to-use software on the market. Instantly calculate precise drop, lead and windage corrections, even at extreme ranges, that would otherwise require countless hours and hundreds of shots at the range.

## Improve the performance of factory ammunition.

The most comprehensive database of commercially loaded ammunition of any ballistics program. We've done our homework, so you don't have to.

## Instant access to over 500 ballistic coefficients.

Instant retrieval of ballistic coefficients from all major bullet manufacturers.

## Immediate calculations of correction in four measurements.

Corrections in minutes of angle (MOA), inches per hundred yards (I.P.H.Y.), Mil-Radian (Mils) and centimeters per hundred meters (C.P.H.M.).

## Print and archive your data.

Interfaces with Excel® spreadsheets for further analysis at your leisure, allowing you to compare loads, generate reference cards, plot graphs and make custom drop charts.

## More accurate trajectory validation.

Multi-dimensional technology, known as trajectory validation, makes the Nightforce Ballistic Program more accurate than any other commercially available software.

## Detailed reticle analysis, too.

Optimize the use of rangefinder ballistic reticles by changing the magnification or sight-in distance so one or more of the reticle's reference bars, dots and/or circles will coincide with where you want to shoot at a specific distance.

Visit [www.nightforceoptics.com](http://www.nightforceoptics.com) for more information. Contact us for complete details and pricing.

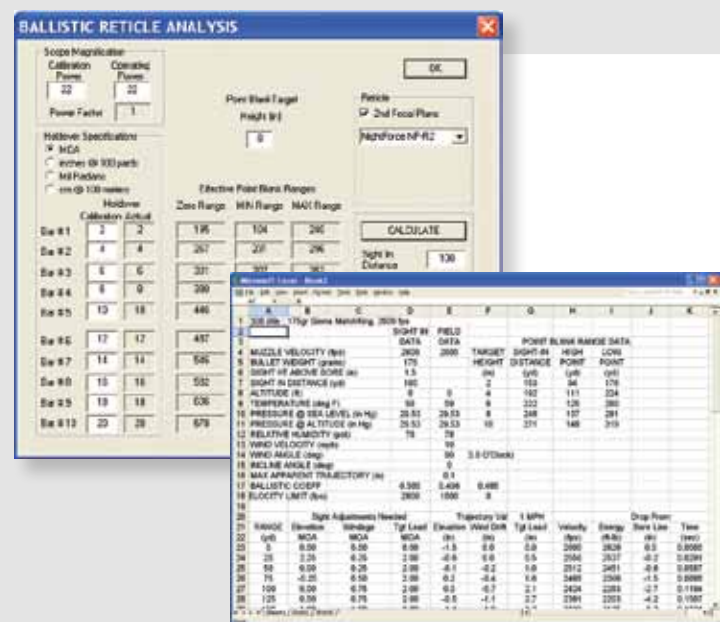

Available for Windows®, Pocket PC and Palm

Formulates zero-point solutions to hit long range targets

Records and recalls sight-in data for location and conditions

Profiles of rifle/ammunition/atmospheric condition scenarios

Performs all necessary calculations for ranging reticles

Calculates corrections in MOA, I.P.H.Y., Mils and C.P.H.M.

Prints reference cards, plot graphs and drop charts

Comprehensive manufactured ammunition database

Export data to Excel® spreadsheets

Affordable for every hunter and shooter

Calculates correction for Coriolus effect and spin drift



## The best of both worlds.

Professional, military and competition shooters have long appreciated the precision made possible by sophisticated ballistic reticles, especially at extreme ranges. But, for the hunter—or for any shooter for whom time is of the essence—traditional ballistic reticle designs are often too complicated, cumbersome, cluttered and slow for effective use in the field.

Not any more.

## Fast, foolproof and uncomplicated.

Our Velocity reticles solve the basic problems that have historically plagued the hunter when presented with a long shot. Now, there's no guessing. No difficult calculations. No estimating holdover. No counting elevation adjustments. Once you've determined the range to your target, simply choose the appropriate elevation/windage mark and hold dead on. They're up to twice as fast as ordinary ballistic reticles.

# NIGHTFORCE VELOCITY RETICLES: A NEW CONCEPT IN SPEED AND ACCURACY.

## Tailored for your rifle and your load.

Some manufacturers tout "one-size-fits-all" ballistic reticle designs that require you to dial down your magnification (not a good idea when shooting at longer ranges), in an attempt to match their reticle's configuration to your rifle...hardly a recipe for speed or precision.

Our Velocity reticles are offered in several configurations based upon the muzzle velocity and caliber of your rifle. Virtually every modern rifle cartridge will mesh perfectly with one of our Velocity series, with minimal point-of-impact deviation.

On our website you'll find an online calculator in which you enter your chosen load's details. It instantly tells you which Velocity reticle is appropriate for your rifle, and provides an optimum sight-in distance to maximize your bullet's trajectory. Sight in your rifle according to these recommendations, and you won't have to worry about holdover again.

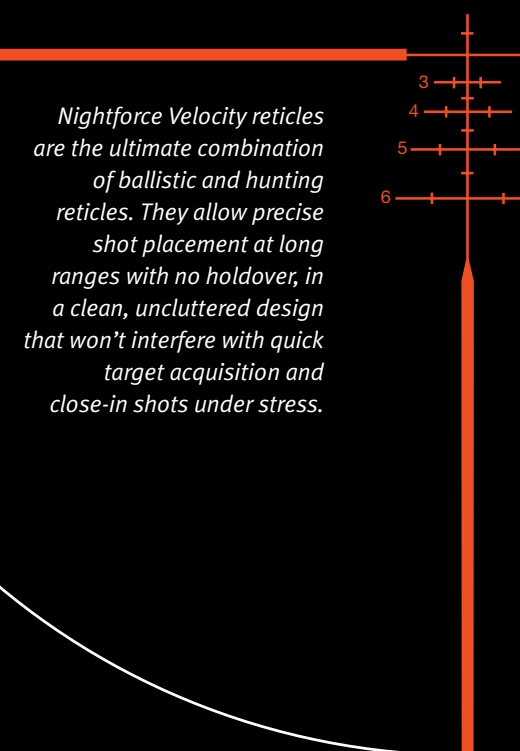

Nightforce Velocity reticles are the ultimate combination of ballistic and hunting reticles. They allow precise shot placement at long ranges with no holdover, in a clean, uncluttered design that won't interfere with quick target acquisition and close-in shots under stress.

## Two versions, one result: Accuracy.

Nightforce Velocity reticles are offered in two basic styles: with 600-yard calibrations for our 2.5-10 x 32 NXS Compact scopes, and with 1000-yard calibrations for our 3.5-15x and 5.5-22x NXS scopes. Like other Nightforce reticles, illumination is standard. In addition to holdover markings, windage compensation in 5 and 10 mph increments (up to 15 mph on the 1000-yard version) is clearly indicated.

Visit [www.nightforceoptics.com](http://www.nightforceoptics.com) for detailed information.

1000-yard Velocity reticles available by mid-2011.

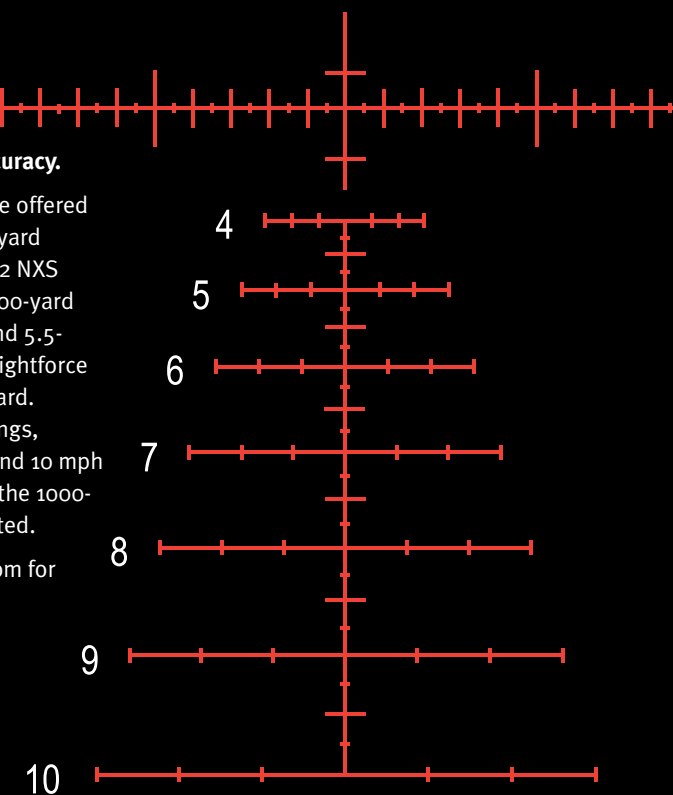



# RETICLES

Nightforce offers a wide range of sophisticated reticles that maximize the effectiveness of our riflescopes. While many scope companies treat reticles as an afterthought, each Nightforce reticle is designed for ultimate performance within specific applications. This is the only way to achieve the highest degree of repeatable, predictable accuracy possible...making your choice of reticle almost as important as your choice of rifle scope.

Illumination is standard on all Nightforce reticles.

*Nightforce parallax adjustment and reticle illumination control is located on the left side of the scope. Pulling out the adjustment activates reticle illumination, while turning the adjustment alone adjusts parallax. It is a patented system only from Nightforce. On fixed-parallax Nightforce scopes, the left-side adjustment controls illumination only.*

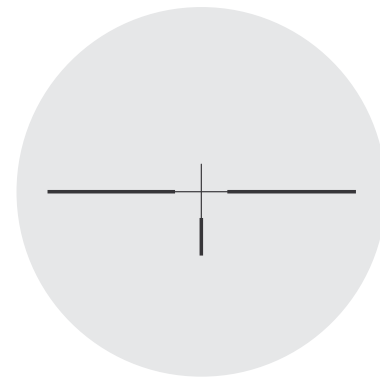

**NP-1**  
Big game hunting  
Superior to duplex reticles, eliminating heavy posts that obstruct your view. The eye is directed to center for quick target acquisition.

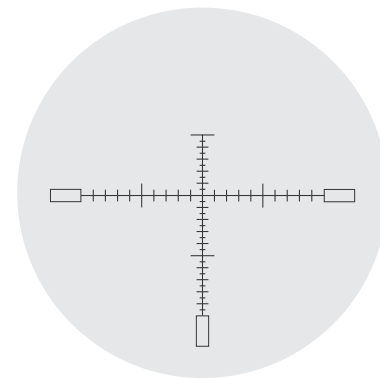
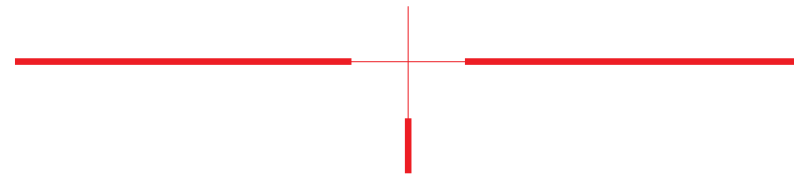

**NP-R1**  
Field tactical  
Varmint  
Long-range hunting  
1 MOA elevation spacing and 2 MOA windage spacing is ideal for precision long range shooting, benchrest and all-around use. Also effective for rangefinding objects of various sizes.

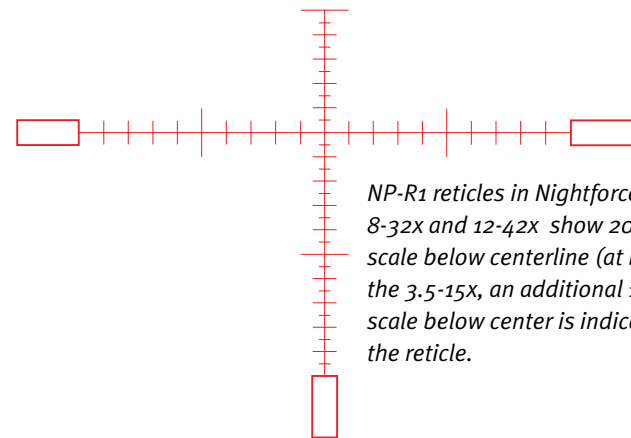

*NP-R1 reticles in Nightforce 5.5-22x, 8-32x and 12-42x show 20 MOA scale below centerline (at left). In the 3.5-15x, an additional 10 MOA scale below center is indicated on the reticle.*

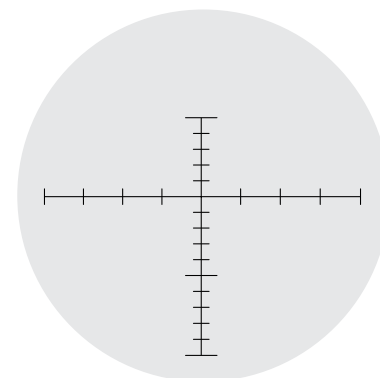

**NP-R2**  
Field tactical  
Varmint  
Long-range hunting  
2 MOA vertical increments allow accurate rangefinding and multiple zero and hold points to compensate for windage and bullet drop. Excellent for long-range applications.

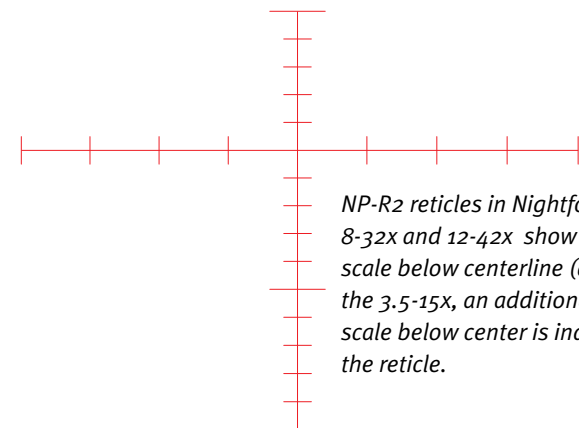

*NP-R2 reticles in Nightforce 5.5-22x, 8-32x and 12-42x show 20 MOA scale below centerline (at left). In the 3.5-15x, an additional 10 MOA scale below center is indicated on the reticle.*

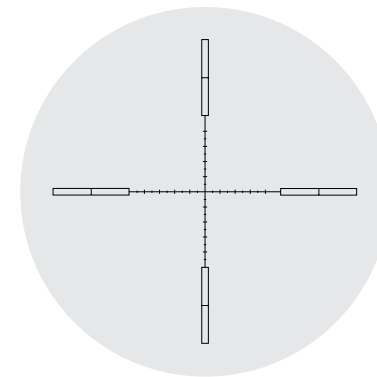

**MLR**  
Field tactical  
Long-range hunting  
.5 mil and 1 mil divisions allow for multiple zeroes, holdover, hold-under and windage adjustments without touching elevation or windage knobs. Excellent for range estimation.

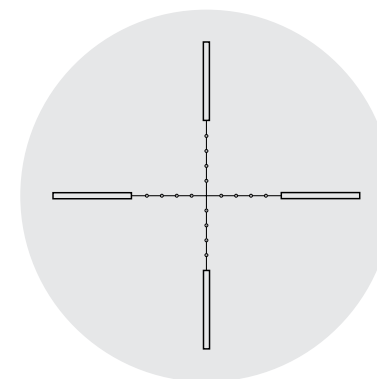
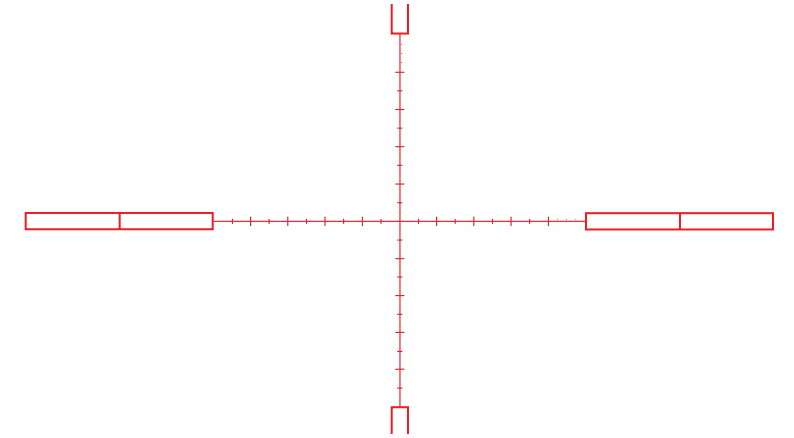

**MIL-DOT**  
Field tactical  
See-through dots and target posts do not obscure target, allowing for more precise estimation of range. 1 mil spacing between dots (3.6" at 100 yards).

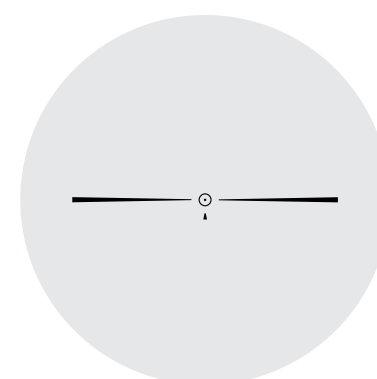
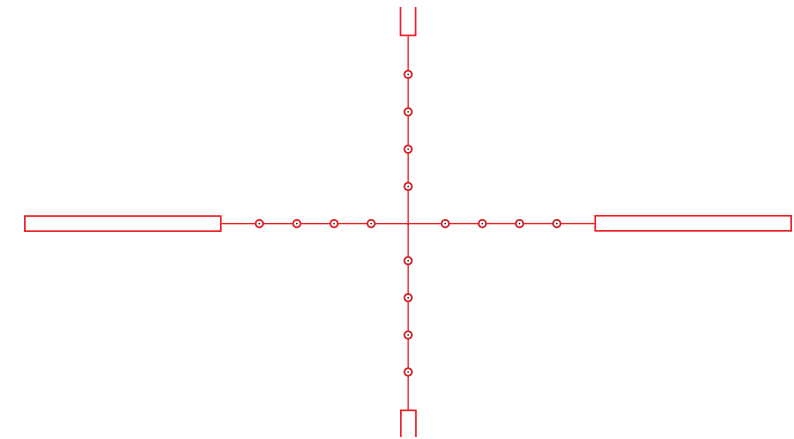

**FC-2**  
CQB  
General hunting  
The center dot provides a precise aim point, while the larger circle gives a wider zone for fast or moving shots. The triangle under the circle can be used as a 10 MOA holdover point from center dot and as a ranging tool.

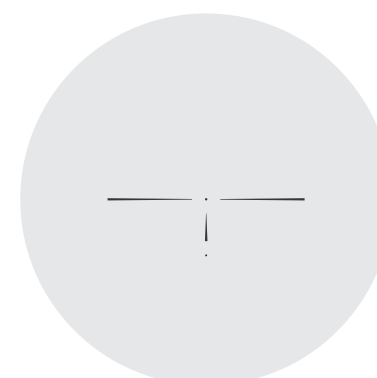

**NP-2DD**  
Varmint hunting  
1000-yard benchrest  
Unobstructed field of view and precise MOA reference markings serve the predator hunter and benchrest competitor equally well. Simple and effective at close and long ranges.





# RETICLES

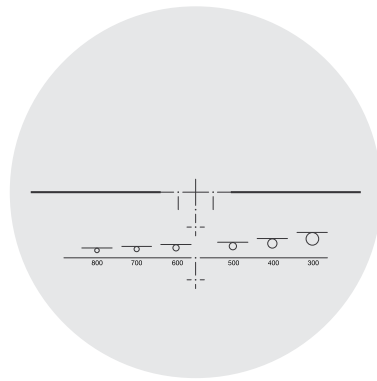

**NP-1RR**  
Varmint hunting  
Long-range hunting

Works on principle of known target size to provide easy rangefinding and quick, accurate compensation for wind drift and bullet drop.

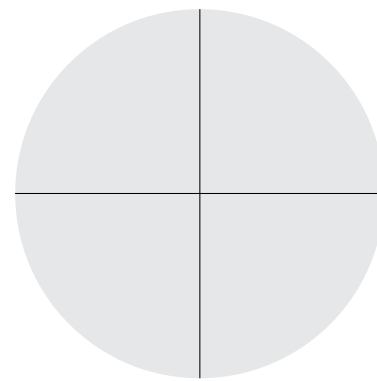
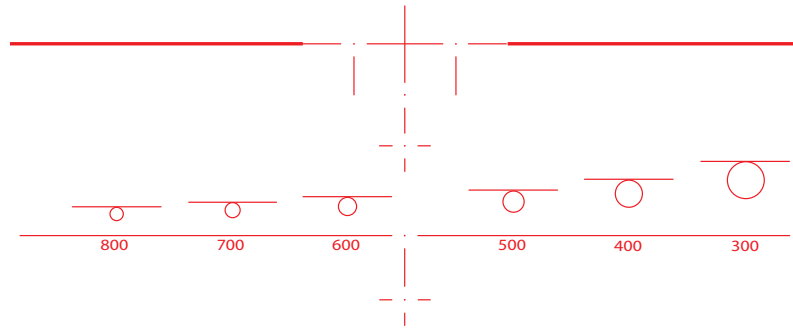

**CH-1**  
Benchrest

Subtension of .036 MOA, selected after extensive research to give competitors a reticle highly suited for benchrest competition. Unobstructed field of view allows shooter to observe wind flags.

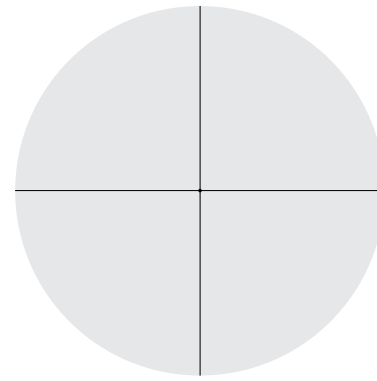
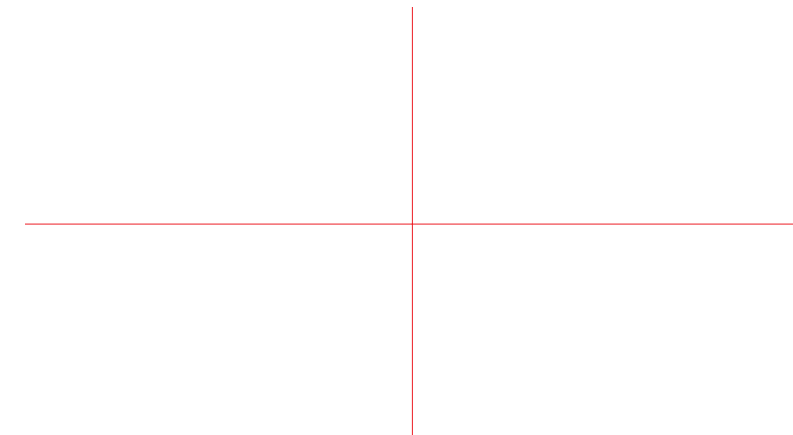

**CH-2**  
High-power competition

Designed for long-range, high-power competition. .200 MOA dot on a .036 MOA crosshair (at 22x). Dot is calibrated for scored shooting on NRA high-power targets. The choice of the U.S. Army Marksmanship Unit.

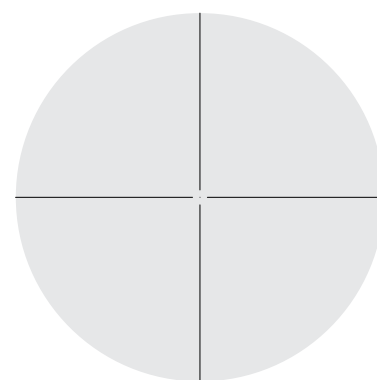
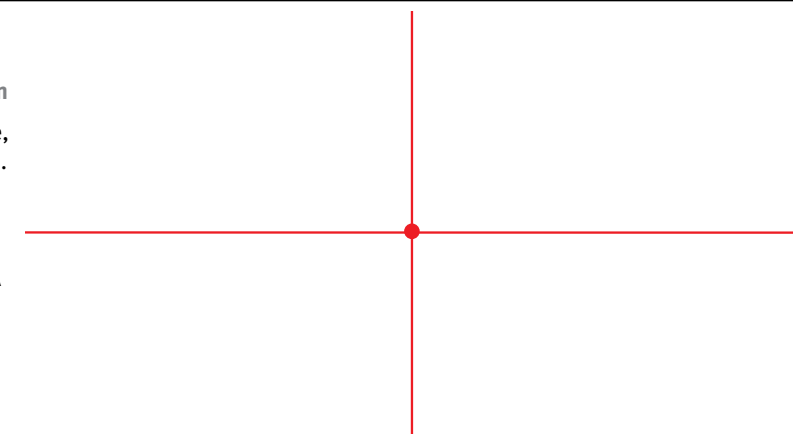

**CH-3**  
Benchrest

Extremely fine crosshair and floating dot permits compensation for mirage and wind conditions in 1 MOA increments. Allows bracketing of bullseye while maintaining center aim point.

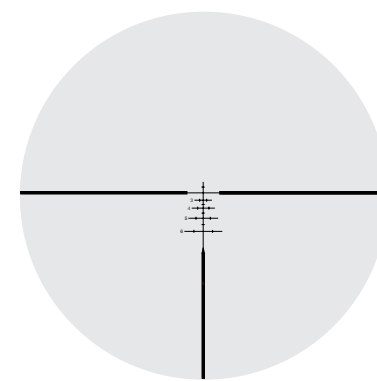
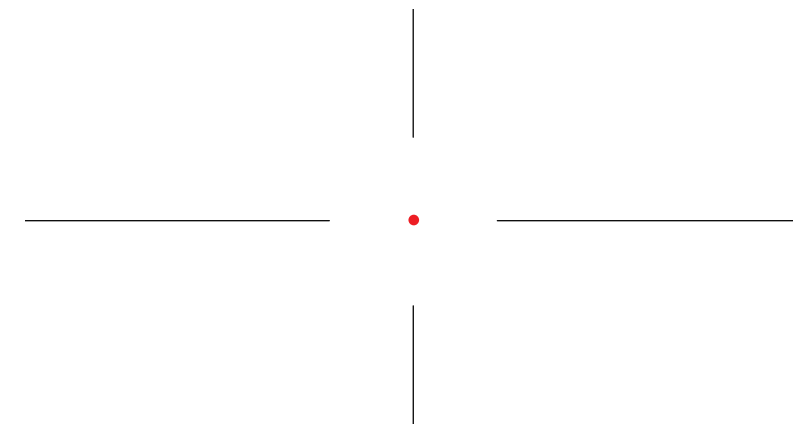

**Velocity 600 yard**  
General hunting

Precise shot placement to 600 yards with no holdover. Low, medium and high velocity configurations. Available in our 2.5-10 x 32 NXS only.

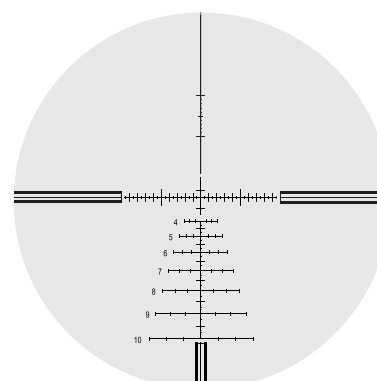
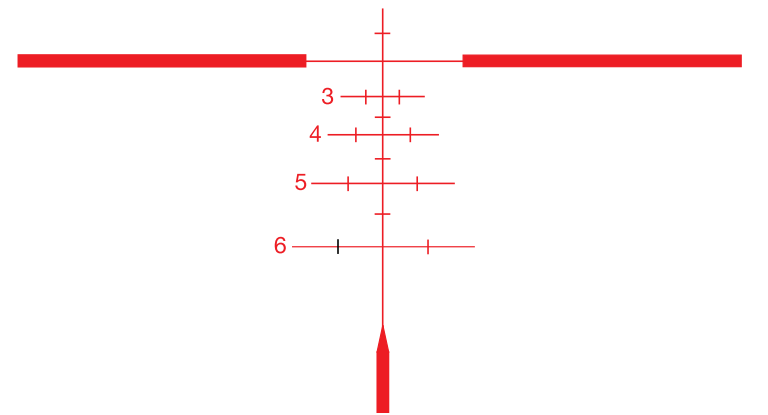

**Velocity 1000 yard**  
General hunting

Precise shot placement to 1000 yards with no holdover. Available mid-2011. Configuration may differ from that pictured here.

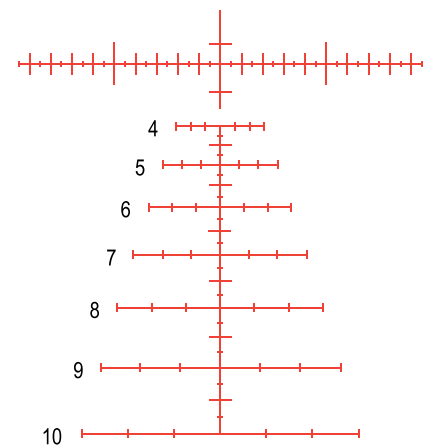

**1000 yards, 10 shots, 3.04 inches**

"After researching several scope brands, I purchased a Nightforce 12-42 in 1997...I can honestly say Nightforce is in a league of its own. My first Nightforce scope had its 12th birthday this year [2009] and was instrumental in helping me achieve a new World Record."

—Joel Pendergraft

**Good as gold**

Using Nightforce 12-42 x 56 NXS scopes, Team Savage won the 2010 National Championships Team Match, taking the 600 and 1000 yard phases, setting a new 1000 yard national record, and outscoring all nine competing F-TR teams. "The mirage was particularly fierce," said Darrell Buell, Team USA captain. "The quality of our optics played a significant role in the win."



**Our sincerest thanks...**

To all our customers and friends who so kindly share their adventures, accomplishment and photographs with us. If you have a Nightforce story, please share it with us. We read and appreciate every one.

**2003 World Record**

"The superior image detail, quality and precision adjustments on my Nightforce 12-42 x 56 was exactly the confidence builder I needed to secure the 1000 yard benchrest world record, for group, in 2003-2006 (Light Gun class). I am convinced that without Nightforce, there wouldn't have been a ten-shot, 4.2275" group at 1000 yards, and no world record for me."

—Kyle Brown



**Understatement?**

According to one U.S. sniper in Iraq, Nightforce "holds and retains zero, even after getting banged around a little." We know what "banged around" means in a combat situation. If you saw how thoroughly we test every scope before it leaves our facility, a little banging around is of no concern at all.



# THE NIGHTFORCE 3.5-15 x 50 F1. FIRST FOCAL PLANE. FIRST IN SPEED AND ACCURACY.

The U.S. military asked for a scope that is exceptionally fast and applicable to a wide range of targets at various distances.

The 3.5-15 x 50 F1 NXS is the answer. The reticle is located in the first focal plane, which has distinct advantages in high-stress situations and when the user might encounter targets from up-close to 1000 yards or more.

A first focal plane reticle remains in the same visual proportion to the target across the scope's entire magnification range, making it especially appropriate with rangefinding reticles. Combined with Nightforce highly tactile and intuitive adjustments, it makes for a scope that is extremely quick, accurate, responsive and utterly reliable.



Nightforce ZeroStop adjustments are standard in the F1. In addition, a set of Nightforce Ultralight rings is included (NF100UL).

The 3.5-15 x 50 F1 NXS can be ordered with optional ballistic adjustment caps to match certain standard loads.

Visit [www.nightforceoptics.com](http://www.nightforceoptics.com) for complete details.

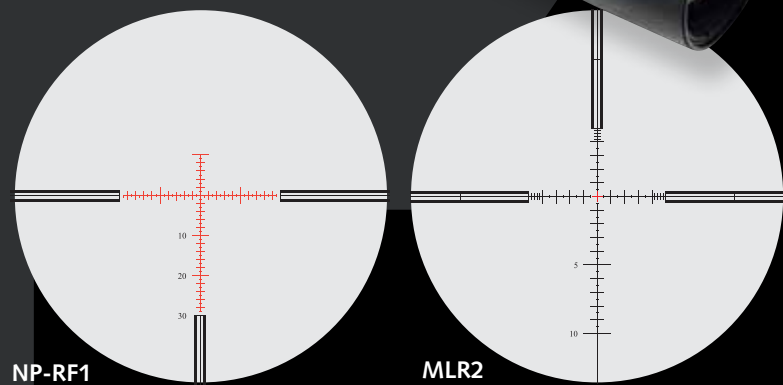

NP-RF1

MLR2

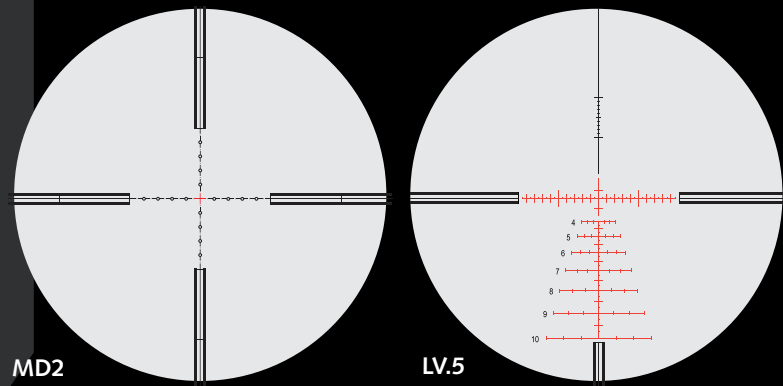

MD2

LV.5

Several reticles are offered exclusively in the F1, each designed to maximize effectiveness of the first focal plane location.

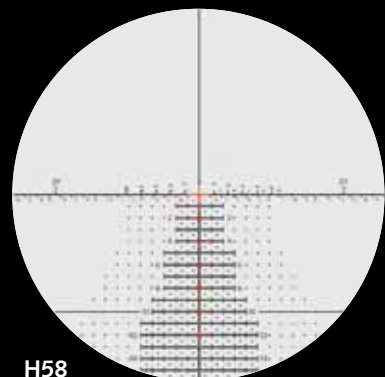

H58

F1 Hi-Speed adjustments, L to R:  
.250 MOA with ZeroStop  
.1 Mil-Radian with ZeroStop

## SPECIFICATIONS

Every Nightforce scope is guaranteed against defects in materials and workmanship for as long as you own it. Please refer to the back cover for warranty details. All service work is performed in-house at our headquarters in central Idaho.



1-4-24 NXS	2.5-10x32 NXS	3.5-15x50 NXS	3.5-15x50 F1 NXS	3.5-15x56 NXS	5.5-22x50 NXS	5.5-22x56 NXS	8-32x56 NXS	12-42x56 NXS	8-32x56 Benchrest	12-42x56 Benchrest
------------	---------------	---------------	------------------	---------------	---------------	---------------	-------------	--------------	-------------------	--------------------

<b>Objective diameter</b>										
24 mm	32 mm	50 mm	50 mm	56 mm	50 mm	56 mm	56 mm	56 mm	56 mm	56 mm
<b>Exit pupil diameter</b>										
1x: 16 mm	2.5x: 13.3 mm	3.5x: 14.3 mm	3.5x: 11.5 mm	3.5x: 14.5 mm	5.5x: 9.1 mm	5.5x: 10.2 mm	8x: 7.0 mm	12x: 4.7 mm	8x: 5.6 mm	12x: 4 mm
4x: 6 mm	10x: 3.3 mm	15x: 3.6 mm	15x: 3.2 mm	15x: 4.0 mm	22x: 2.3 mm	22x: 2.5 mm	32x: 1.8 mm	42x: 1.3 mm	32x: 1.7 mm	42x: 1.4 mm
<b>Field of view @100 yards/100 meters</b>										
1x: 100 ft	2.5x: 44 ft	3.5x: 27.6 ft	3.5x: 28 ft	3.5x: 27.6 ft	5.5x: 17.5 ft	5.5x: 17.5 ft	8x: 12.1 ft	12x: 8.2 ft	8x: 9.4 ft	12x: 6.7 ft
4x: 25 ft	10x: 11 ft	15x: 7.3 ft	15x: 8.7 ft	15x: 7.3 ft	22x: 4.7 ft	22x: 4.7 ft	32x: 3.1 ft	42x: 2.4 ft	32x: 3.1 ft	42x: 2.3 ft
1x: 30.5 m	2.5x: 13.4 m	3.5x: 8.4 m	3.5x: 8.5 m	3.5x: 8.4 m	5.5x: 5.3 m	5.5x: 5.3 m	8x: 3.7 m	12x: 2.5 m	8x: 2.9 m	12x: 2 m
4x: 7.6 m	10x: 3.4 m	15x: 2.2 m	15x: 2.6 m	15x: 2.2 m	22x: 1.4 m	22x: 1.4 m	32x: 1 m	42x: 0.7 m	32x: 1 m	42x: 0.7 m
<b>Eye relief</b>										
90 mm/3.5"	95 mm/3.7"	99 mm/3.9"	80 mm/3.15"	97 mm/3.8"	95 mm/3.7"	99 mm/3.9"	98 mm/3.8"	98 mm/3.8"	75 mm/2.9"	75 mm/2.9"
<b>Internal adjustment range (MOA/Mil)</b>										
e: 100 MOA	e: 100 MOA	e: 110 MOA	e: 110 MOA	e: 110 MOA	e: 100 MOA	e: 100 MOA	e: 65 MOA	e: 45 MOA	e: 50 MOA	e: 40 MOA
w: 100 MOA	w: 100 MOA	w: 80 MOA	w: 80 MOA	w: 80 MOA	w: 60 MOA	w: 60 MOA	w: 45 MOA	w: 35 MOA	w: 50 MOA	w: 40 MOA
e: 27.3 MIL	e: 27.3 MIL	e: 30 MIL	e: 30 MIL	e: 30 MIL	e: 27.3 MIL	e: 27.3 MIL	e: 17.7 MIL	e: 12.3 MIL	e: 13.6 MIL	e: 10.9 MIL
w: 27.3 MIL	w: 27.3 MIL	w: 21.8 MIL	w: 21.8 MIL	w: 21.8 MIL	w: 16.4 MIL	w: 16.4 MIL	w: 12.3 MIL	w: 9.5 MIL	w: 13.6 MIL	w: 10.9 MIL
<b>Click value</b>										
.250 MOA	.250 MOA	.250 MOA	.250 MOA	.250 MOA	.250 MOA	.250 MOA	.125/.250 MOA	.125/.250 MOA	.125 MOA	.125 MOA
.1 MIL-RAD	.1 MIL-RAD	.1 MIL-RAD	.1 MIL-RAD	.1 MIL-RAD	.1 MIL-RAD	.1 MIL-RAD	.1 MIL-RAD	.1 MIL-RAD		
<b>Tube diameter</b>										
30 mm/1.18"	30 mm/1.18"	30 mm/1.18"	30 mm/1.18"	30 mm/1.18"	30 mm/1.18"	30 mm/1.18"	30 mm/1.18"	30 mm/1.18"	30 mm/1.18"	30 mm/1.18"
<b>Ocular lens diameter</b>										
33 mm	33 mm	36 mm	36 mm	36 mm	36 mm	36 mm	36 mm	36 mm	36 mm	36 mm
<b>Overall length</b>										
8.8"	12"	14.7"	14.8"	14.8"	15.1"	15.2"	15.9"	16.1"	16.6"	17"
<b>Weight</b>										
17 oz	19 oz	30 oz	30 oz	31 oz	31 oz	32 oz	34 oz	34 oz	36 oz	36 oz
<b>Mounting length</b>										
5.4"	5.7"	6.1"	6.2"	5.8"	6.6"	6.6"	6.7"	6.9"	5.5"	5.9"
<b>Reticles available (illuminated reticles standard on all Nightforce scopes except for certain special contract products)</b>										
NP-1	NP-1	NP-1RR	NP-RF1 *	NP-1RR	NP-1RR	NP-1RR	NP-1RR	NP-1RR	NP-1RR	NP-1RR
FC-2	NP-R2	NP-1	MLR2*	NP-1	NP-1	NP-1	NP-1	NP-1	NP-1	NP-1
MIL-DOT	FC-2	NP-R1	MD2*	NP-R1	NP-R1	NP-R1	NP-R1	NP-R1	NP-R1	NP-R2
	MIL-DOT	NP-R2	LV.5*	NP-R2	NP-R2	NP-R2	NP-R2	NP-R2	NP-R2	NP-2DD
	LV, MV, HV	NP-2DD	H-58*	NP-2DD	NP-2DD	NP-2DD	NP-2DD	NP-2DD	NP-2DD	CH1
		MLR		MLR	CH1	CH1	CH1	CH1	CH1	CH2
		MIL-DOT	*new 2011	MIL-DOT	CH2	CH2	CH2	CH2	CH2	CH3
					CH3	CH3	CH3	CH3	CH3	MIL-DOT
					MLR	MLR	MLR	MLR	MLR	MIL-DOT
					MIL-DOT	MIL-DOT	MIL-DOT	MIL-DOT	MIL-DOT	
<b>ZeroStop option available?</b>										
Yes	Yes	Yes	Standard	Yes	Yes	Yes	Yes	No	No	No





Nightforce is located in Orofino, Idaho. It might seem odd to find such a state-of-the-art facility in a small town, but it is an ideal location for intense testing of our riflescopes.

Nightforce was created in 1992 with one goal in mind; to build the finest riflescopes on the market for the professional shooter. The same qualities that have made Nightforce the choice of professionals have now created a dedicated following among hunters and serious shooters.

Try one, and you will understand why.



# NIGHTFORCE™

## Factory/Headquarters USA:

Nightforce Optics, Inc.  
336 Hazen Lane  
Orofino, ID 83544

## Technical & Warranty:

tel 208.476.9814  
fax 208.476.9817  
NightforceOptics.com

## Dealer & Distributor Global Sales :

Nightforce Optics, Inc.  
1087 E. Franklin Street, Suite D  
Hartwell, GA 30643  
tel 706.377.3192  
fax 706.377.3187

## Australia & South Pacific sales:

Nightforce Optics  
28 Orsmond Street  
Hindmarsh, SA 5007  
Australia  
tel +61 (0)8 8440 0888  
fax +61 (0)8 8346 0504



A Lightforce company

## Guaranteed for life.

Every Nightforce riflescope comes with a Limited Lifetime Warranty which covers mechanical defects in materials and workmanship in the optical and mechanical components. In the event of a covered defect in materials or workmanship, we will either repair the riflescope or replace it at no charge with a comparable product at our discretion.

Exclusions include intentional or accidental damage, abuse, misuse, unauthorized modifications or repairs, and improper mounting.

Contact us or visit our website for complete details.



1-4 x 24 NXS



2.5-10 x 32 NXS



3.5-15 x 50 NXS



3.5-15 x 50 F1 NXS



3.5-15 x 56 NXS



5.5-22 x 50 NXS



5.5-22 x 56 NXS



8-32 x 56 NXS



12-42 x 56 NXS



8-32 x 56 Precision Benchrest



12-42 x 56 Precision Benchrest

© Nightforce Optics, Inc. 2010 12/10

All information herein is accurate at time of printing. Some scopes above shown with optional ZeroStop™.